

Instruction Manual

**HI 2314
HI 2315 • HI 23151**

**Multi-Range
Conductivity Meters
for Laboratories**

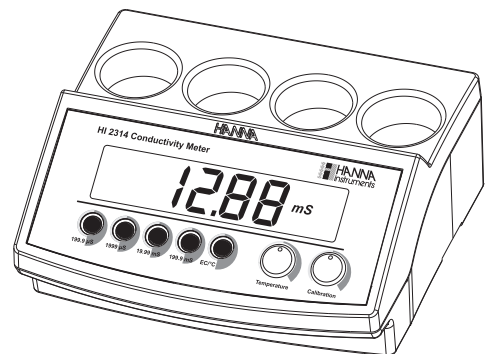

www.hannainst.com

Dear Customer,

Thank you for choosing a Hanna Instruments product.

Please read this instruction manual carefully before using these instruments. This manual will provide you with the necessary information for correct use of these instruments, as well as a precise idea of their versatility.

If you need additional technical information, do not hesitate to e-mail us at tech@hannainst.com or view our worldwide contact list at www.hannainst.com.

WARRANTY

HI 2314, HI 2315 and HI 23151 are guaranteed for two years against defects in workmanship and materials when used for their intended purpose and maintained according to instructions.

Electrodes and probes are guaranteed for six months.

This warranty is limited to repair or replacement free of charge.

Damages due to accidents, misuse, tampering or lack of prescribed maintenance is not covered.

If service is required, contact the dealer from whom you purchased the instrument.

If under warranty, report the model number, date of purchase, serial number and the nature of the problem.

If the repair is not covered by the warranty, you will be notified of the charges incurred.

If the instrument is to be returned to Hanna Instruments, first obtain a Returned Goods Authorization number from the Technical Service department and then send it with shipping costs prepaid.

When shipping any instrument, make sure it is properly packed for complete protection.

TABLE OF CONTENTS

WARRANTY	2
PRELIMINARY EXAMINATION	4
GENERAL DESCRIPTION	4
FUNCTIONAL DESCRIPTION HI 2314	5
SPECIFICATIONS HI 2314	6
FUNCTIONAL DESCRIPTION HI 2315	7
SPECIFICATIONS HI 2315 AND HI 23151	8
OPERATIONAL GUIDE	9
CALIBRATION	11
CONDUCTIVITY VS. TEMPERATURE CHART	14
DETERMINATION OF THE TEMPERATURE COEFFICIENT OF A SOLUTION (HI 2315)	15
PROBE MAINTENANCE	16
ACCESSORIES	17

PRELIMINARY EXAMINATION

Remove the instrument from the packing material and examine it carefully to make sure that no damage has occurred during shipping. If there is any damage, notify your dealer.

Each meter is supplied complete with:

- 4-ring conductivity probe with 1 m (3.3') cable
 - **HI 76300** for **HI 2314**
 - **HI 76303** for **HI 2315** and **HI 23151**
- 12 Vdc adapter
- Instruction manual

Note: Save all packing material until you are sure that the instrument functions correctly. All defective items must be returned in the original packing with the supplied accessories.

GENERAL DESCRIPTION

HI 2314 and **HI 2315** are bench top multi-range conductivity meters for the laboratory.

Four measurement ranges ensure the highest resolution and precision for your measuring requirements.

Single point calibration is performed manually simply by adjusting a knob on the front of the meter.

Temperature compensation of the readings is automatic for the **HI 2315** and **HI 23151** models, thanks to the temperature sensor incorporated in probe, with userselectable temperature coefficient.

With **HI 2314** the temperature compensation is manual and the temperature value can be also set with a knob.

The rugged probe with platinum 4-ring sensor responds faster than conventional stainless steel models and can be also used for measuring highly acidic or alkaline samples, or at high temperature.

In addition, the **HI 23151** model offers analog output of 0 to 5V that represents the full conductivity scale across all 4 ranges.

FUNCTIONAL DESCRIPTION HI 2314

Front Panel

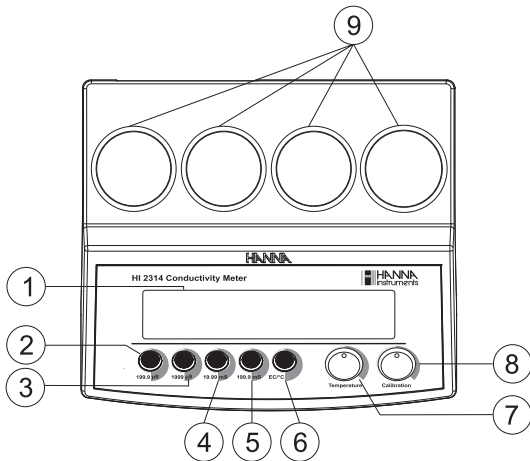

Rear Panel

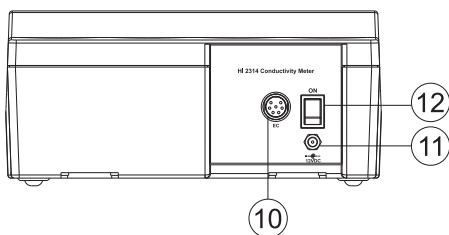

- 1) Liquid Crystal Display (LCD)
- 2) 199.9 μS key for range selection
- 3) 1999 μS key for range selection
- 4) 19.99 mS key for range selection
- 5) 199.9 mS key for range selection
- 6) EC/°C key, to select conductivity reading or temperature setting for manual compensation
- 7) Temperature setting knob for manual compensation
- 8) Conductivity Calibration knob
- 9) Sample holders
- 10) Probe connector
- 11) Power adapter socket
- 12) ON/OFF switch

SPECIFICATIONS HI 2314

RANGE	0.0 to 199.9 $\mu\text{S}/\text{cm}$ 0 to 1999 $\mu\text{S}/\text{cm}$ 0.00 to 19.99 mS/cm 0.0 to 199.9 mS/cm
RESOLUTION	0.1 $\mu\text{S}/\text{cm}$ 1 $\mu\text{S}/\text{cm}$ 0.01 mS/cm 0.1 mS/cm
ACCURACY (@25 °C/ 77 °F)	$\pm 1\%$ FS (excluding probe error)
Calibration	Manual, single point, through front knob
Temperature Compensation	Manual, 0 to 50 °C (32 to 122 °F) with $\beta = 2\%/^{\circ}\text{C}$
Probe (included)	HI 76300 , platinum 4-ring sensor, with 1 m (3.3') cable
Power Supply	12 Vdc adapter (included)
Environment	0 to 50 °C (32 to 122 °F) RH max 95% non-condensing
Dimensions	235 x 222 x 109 mm (9.2 x 8.7 x 4.3")
Weight	1.3 Kg (2.9 lbs)

FUNCTIONAL DESCRIPTION HI 2315 / HI 23151

Front Panel

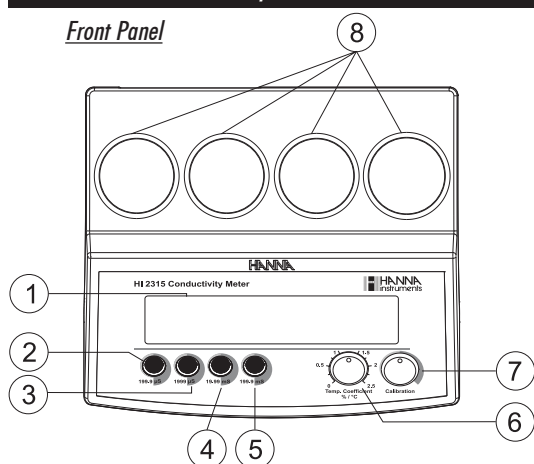

Rear Panel

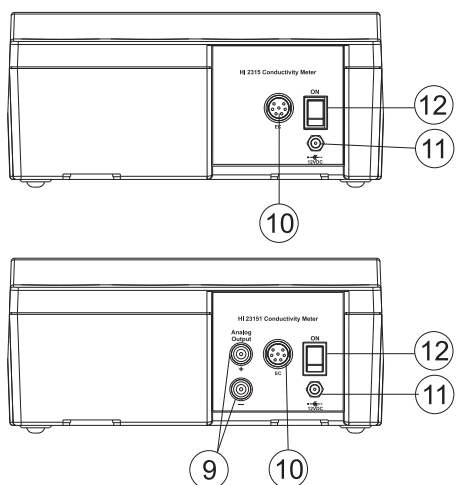

- 1) Liquid Crystal Display (LCD)
- 2) 199.9 μS key for range selection
- 3) 1999 μS key for range selection
- 4) 19.99 mS key for range selection
- 5) 199.9 mS key for range selection
- 6) Temp. Coefficient knob for manual compensation

6

- 7) Conductivity Calibration knob
- 8) Sample holders
- 9) Analog output (HI 23151 only)
- 10) Probe connector
- 11) Power adapter socket
- 12) ON/OFF switch

SPECIFICATIONS HI 2315 / HI 23151

RANGE	0.0 to 199.9 $\mu\text{S}/\text{cm}$ 0 to 1999 $\mu\text{S}/\text{cm}$ 0.00 to 19.99 mS/cm 0.0 to 199.9 mS/cm
RESOLUTION	0.1 $\mu\text{S}/\text{cm}$ 1 $\mu\text{S}/\text{cm}$ 0.01 mS/cm 0.1 mS/cm
ACCURACY (@25 °C/ 77 °F)	$\pm 1\%$ FS (excluding probe error)
Calibration	Manual, single point, through front knob
Temperature Compensation	Automatic, 0 to 50 °C (32 to 122 °F) with B adjustable from 0 to 2.5%/°C
Probe (included)	HI 76303, platinum 4-ring sensor, built-in temperature sensor and 1 m (3.3') cable
Analog Output (HI 23151 only)	0 to 5 Vdc not isolated output; accuracy $\pm 0.1\%$ of reading; resolution ± 2.5 mV
Power Supply	12 Vdc power adapter (included)
Environment	0 to 50 °C (32 to 122 °F) RH max 95% non-condensing
Dimensions	235 x 222 x 109 mm (9.2 x 8.7 x 4.3")
Weight	1.3 Kg (2.9 lbs)

7

OPERATIONAL GUIDE

Power connection

Plug the 12 Vdc adapter into the power supply socket.

Note: Make sure the main line is protected by a fuse.

Probe connection

Connect the conductivity probe to the proper socket on the rear panel.

Note: Make sure that the instrument has been calibrated before taking any measurement (see "Calibration" section).

Note: If possible, use plastic beakers to minimize EMC interferences.

TAKING CONDUCTIVITY MEASUREMENTS WITH HI 2314

- Switch the instrument on by pressing **ON/OFF**.



- Immerse the probe in the solution while completely submerging the holes of the sleeve. Tap the probe lightly on the bottom of the beaker to remove any air bubbles trapped inside the sleeve. Measure the solution temperature with a **Checktemp** or another accurate thermometer.



- Press and hold the **EC/°C** key to select temperature setting.
- Adjust the **Temperature** knob to display the temperature of the solution on the LCD.

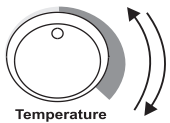

- Release the **EC/°C** key to select conductivity reading.



- Select the appropriate conductivity range.



Note: If the display shows range limit value blinking, there is an over-range condition. Select the next higher range.

- Allow a few minutes for the reading to stabilize. The LCD will display the temperature compensated conductivity reading.



TAKING CONDUCTIVITY MEASUREMENTS WITH HI 2315

- Switch the instrument on by pressing **ON/OFF**.



- Immerse the probe in the solution while completely submerging the holes of the sleeve. Tap the probe lightly on the bottom of the beaker to remove any air bubbles trapped inside the sleeve.



- Adjust the **Temp. Coefficient** knob to the temperature coefficient value of the solution (see "Determination of the Temperature Coefficient of a Solution" section for details).

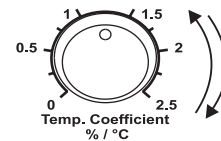

- Select the appropriate conductivity range.



Note: If the display shows range limit value blinking, there is an over-range condition. Select the next higher range.

- Allow a few minutes for the reading to stabilize. The LCD will display the temperature compensated conductivity reading.



CALIBRATION

The instrument should be calibrated at least once a month, or when the probe is changed.

INITIAL PREPARATION

For better accuracy of measurements it is recommended to use the calibration solution with a conductivity value as close as possible to the sample to be measured. See the "Accessories" section for a complete list of available HANNA calibration solution.

Rinse the probe thoroughly in distilled water.

If possible, use plastic beakers to minimize any EMC interferences.

PROCEDURE FOR HI 2314

- Pour a small quantity of the appropriate calibration solution, e.g. **HI 7030** (12.88 mS/cm @ 25°C), into a plastic beaker.



- Immerse the probe in the solution while completely submerging the holes of the sleeve. Tap the probe lightly on the bottom of the beaker to remove any air bubbles trapped inside the sleeve. Measure the solution temperature with a **Checktemp** or another accurate thermometer.



- Press and hold the EC/°C key to select temperature setting.



- Adjust the **Temperature** knob to display the temperature of the solution on the LCD.

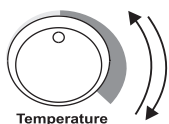

- Release EC/°C to select conductivity reading and select the appropriate range:

199.9 μ S for HI 7033

1999 μ S for HI 7031

19.99 mS for HI 7030

199.9 mS for HI 7034



Note: If the display shows range limit value blinking, there is an over-range condition. Select the next higher range.

- Allow a few minutes for the reading to stabilize, then adjust the **Calibration** knob to read the calibration solution conductivity value at 25°C (77°F), e.g. 12.88 mS/cm.

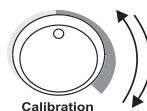

- All subsequent measurements will be referenced to 25°C (77°F).
- To reference the measurements to 20°C (68°F), adjust the **Calibration** knob to read the calibration solution conductivity value at 20°C (68°F), e.g. 11.67 mS/cm. See the "Conductivity vs. Temperature Chart" on page 13.
- Calibration is now complete and the instrument is ready for use.

PROCEDURE FOR HI 2315

- Pour a small quantity of the appropriate calibration solution, e.g. **HI 7030** (12.88 mS/cm @ 25°C), into a plastic beaker.



- Immerse the probe in the solution while completely submerging the holes of the sleeve. Tap the probe lightly on the bottom of the beaker to remove any air bubbles trapped inside the sleeve.

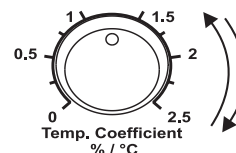
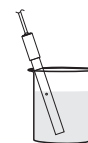

- Adjust the **Temp. Coefficient** knob to 2%/°C.
- Select the appropriate range:
 - 199.9 μS for HI 7033
 - 1999 μS for HI 7031
 - 19.99 mS for HI 7030
 - 199.9 mS for HI 7034

Note: If the display shows range limit value blinking, there is an over-range condition. Select the next higher range.

- Allow a few minutes for the reading to stabilize, then adjust the **Calibration** knob to read the calibration solution conductivity value at 25°C (77°F), e.g. 12.88 mS/cm.

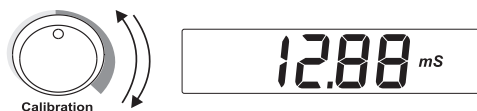

- All subsequent measurements will be referenced to 25°C (77°F).
- To reference the measurements to 20°C (68°F), adjust the **Calibration** knob to read the calibration solution conductivity value at 20°C (68°F), e.g. 11.67 mS/cm. See the “Conductivity vs. Temperature Chart” on page 13.
- Calibration is now complete and the instrument is ready for use.

CONDUCTIVITY VERSUS TEMPERATURE CHART

The conductivity of an aqueous solution is the measure of its ability to carry an electrical current by means of ionic motion.

The conductivity invariably increases with increasing temperature.

It is affected by the type and number of ions in the solution and by the viscosity of the solution itself. Both parameters are temperature dependent. The dependency of conductivity on temperature is expressed as a relative change per degree Celsius at a particular temperature, commonly as %/°C.

Since a small difference in temperature causes a large change in conductivity, the readings are usually normalized at 25°C.

°C	°F	HI7030 HI8030 ($\mu\text{S/cm}$)	HI7031 HI8031 ($\mu\text{S/cm}$)	HI7033 HI8033 ($\mu\text{S/cm}$)	HI7034 HI8034 ($\mu\text{S/cm}$)	HI7035 HI8035 ($\mu\text{S/cm}$)	HI7039 HI8039 ($\mu\text{S/cm}$)
0	32	7150	776	64	48300	65400	2760
5	41	8220	896	65	53500	74100	3180
10	50	9330	1020	67	59600	83200	3615
15	59	10480	1147	68	65400	92500	4063
16	60.8	10720	1173	70	67200	94400	4155
17	62.6	10950	1199	71	68500	96300	4245
18	64.4	11190	1225	73	69800	98200	4337
19	66.2	11430	1251	74	71300	100200	4429
20	68	11670	1278	76	72400	102100	4523
21	69.8	11910	1305	78	74000	104000	4617
22	71.6	12150	1332	79	75200	105900	4711
23	73.4	12390	1359	81	76500	107900	4805
24	75.2	12640	1386	82	78300	109800	4902
25	77	12880	1413	84	80000	111800	5000
26	78.8	13130	1440	86	81300	113800	5096
27	80.6	13370	1467	87	83000	115700	5190
28	82.4	13620	1494	89	84900	117700	5286
29	84.2	13870	1521	90	86300	119700	5383
30	86	14120	1548	92	88200	121800	5479
31	87.8	14370	1575	94	90000	123900	5575

HI 2314 manually compensates for temperature differences with a fixed coefficient of 2%/°C.

HI 2315 automatically compensates for temperature differences, and features an user-selectable coefficient that can be manually adjusted through a front knob, from 0 (no compensation) to 2.5%/°C.

DETERMINATION OF THE TEMPERATURE COEFFICIENT OF A SOLUTION (HI 2315)

- Immerse the probe into a solution sample and adjust the **Temp. Coefficient** knob to 0% (no compensation).
- Condition sample and probe at 25°C, and note the conductivity reading C_{25} .
- Condition sample and probe to a temperature $t^{\circ}\text{C}$ (approximately 5°C to 10°C different from 25°C), and note the conductivity reading C_t .
- The temperature coefficient (β) of the solution is then calculated using the following formula:

$$\beta = 100 \times (C_t - C_{25}) / [(t - 25) \times C_{25}]$$

The above procedure is suitable for determining the temperature coefficient in the laboratory where the temperature of the solution can be determined and controlled.

If this is not possible, e.g. during on-site measurements, the following procedure should be used:

- Immerse the probe into the test solution and turn the **Temp. Coefficient** knob to 0% (no compensation).
- Allow the conductivity reading to stabilize (the reading should not change by more than ± 0.2 mS within 1 minute) and record the value, C.
- Repeat the procedure with a different solution temperature, changed by more than 10°C. Wait for the reading to stabilize.
- Adjust the **Temp. Coefficient** knob until the display reads the previously recorded C value.
- The value indicated by the knob is the temperature coefficient of the solution.

PROBE MAINTENANCE

After every series of measurements, rinse the probe with tap water.

If a more thorough cleaning is required, remove the sleeve and clean the probe with a cloth or a nonabrasive detergent.

After cleaning the probe, always recalibrate the instrument.

The 4-ring platinum probe body is made of glass. For this reason great care while handling the probe must be taken.

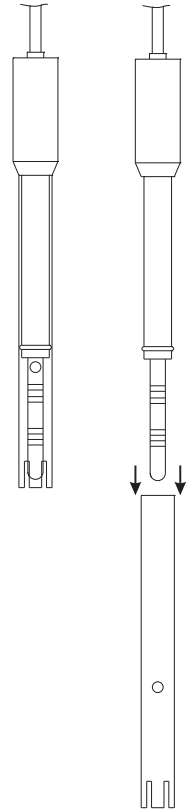

ACCESSORIES

CONDUCTIVITY PROBES

HI 76300	Platinum 4-ring conductivity probe with 1 m (3.3') cable (for HI 2314)
HI 76303	Platinum 4-ring conductivity probe with built-in temperature sensor and 1 m (3.3') cable (for HI 2315)

CONDUCTIVITY CALIBRATION SOLUTIONS

HI 7030M	12880 $\mu\text{S}/\text{cm}$, 230 mL bottle
HI 7030L	12880 $\mu\text{S}/\text{cm}$, 500 mL bottle
HI 8030L	12880 $\mu\text{S}/\text{cm}$, 500 mL FDA bottle
HI 7031M	1413 $\mu\text{S}/\text{cm}$, 230 mL bottle
HI 7031L	1413 $\mu\text{S}/\text{cm}$, 500 mL bottle
HI 8031L	1413 $\mu\text{S}/\text{cm}$, 500 mL FDA bottle
HI 7033M	84 $\mu\text{S}/\text{cm}$, 230 mL bottle
HI 7033L	84 $\mu\text{S}/\text{cm}$, 500 mL bottle
HI 8033L	84 $\mu\text{S}/\text{cm}$, 500 mL FDA bottle
HI 7034M	80000 $\mu\text{S}/\text{cm}$, 230 mL bottle
HI 7034L	80000 $\mu\text{S}/\text{cm}$, 500 mL bottle
HI 8034L	80000 $\mu\text{S}/\text{cm}$, 500 mL FDA bottle
HI 7035M	111800 $\mu\text{S}/\text{cm}$, 230 mL bottle
HI 7035L	111800 $\mu\text{S}/\text{cm}$, 500 mL bottle
HI 8035L	111800 $\mu\text{S}/\text{cm}$, 500 mL FDA bottle
HI 7039M	5000 $\mu\text{S}/\text{cm}$, 230 mL bottle
HI 7039L	5000 $\mu\text{S}/\text{cm}$, 500 mL bottle
HI 8039L	5000 $\mu\text{S}/\text{cm}$, 500 mL FDA bottle

PROBE MAINTENANCE SOLUTIONS

HI 7061M	General cleaning solution, 230 mL bottle
HI 8061M	General cleaning solution, 230 mL FDA bottle
HI 7061L	General cleaning solution, 500 mL bottle
HI 8061L	General cleaning solution, 500 mL FDA bottle

OTHER ACCESSORIES

HI 98501	<i>ChecktempC</i> electronic thermometer (range -50.0 to 150.0°C)
HI 710005	115 Vac / 12 Vdc voltage adapter, US plug
HI 710006	230 Vac / 12 Vdc voltage adapter, European plug

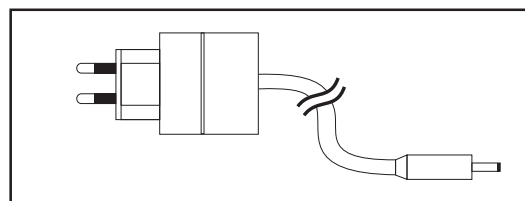

HI 740036	100 mL plastic beaker (6 pcs)
HI 740034	Cap for 100 mL beakers (6 pcs)
HI 76404	Probe holder

RECOMMENDATIONS FOR USERS

Before using this product, make sure that it is entirely suitable for the environment in which they are used.

Operation of this instrument in residential area could cause unacceptable interferences to radio and TV equipment, requiring the operator to take all necessary steps to correct interferences.

The metal band at the end of the sensor is sensitive to electrostatic discharges. Avoid touching this metal band at all times. During calibration, ESD wrist straps should be worn to avoid possible damage to the sensor by electrostatic discharge.

Any variation introduced by the user to the supplied equipment may degrade the instrument's EMC performance. To avoid electrical shock, do not use this instrument when voltages at the measurement surface exceed 24 Vac or 60 Vdc. Use plastic beakers to minimize any EMC interferences.

To avoid damages or burns, do not perform any measurement in microwave ovens.

Hanna Instruments reserves the right to modify the design, construction or appearance of its products without advance notice.

All rights are reserved. Reproduction in whole or in part is prohibited without the written consent of the copyright owner.



Hanna Instruments Inc.
Highland Industrial Park
584 Park East Drive
Woonsocket, RI 02895 USA

Technical Support for Customers

Tel. (800) 426 6287
Fax (401) 765 7575
E-mail tech@hannainst.com
www.hannainst.com

Local Sales and Customer Service Office

